Fitting instructions

Make: Mitsubishi/Citroën/Peugeot

ASX; 2010->

C4 Aircross; 2012->

4008; 2012->

Type: 5313

Art.nr: 6819

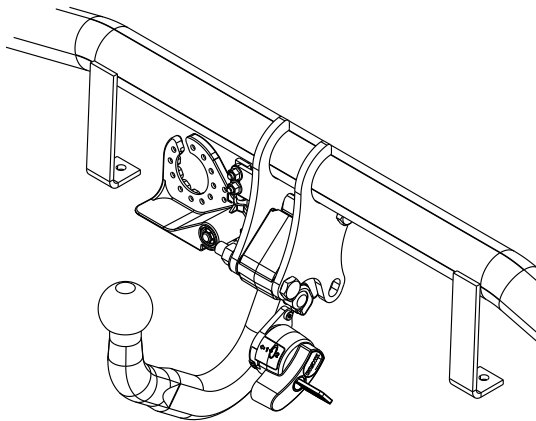

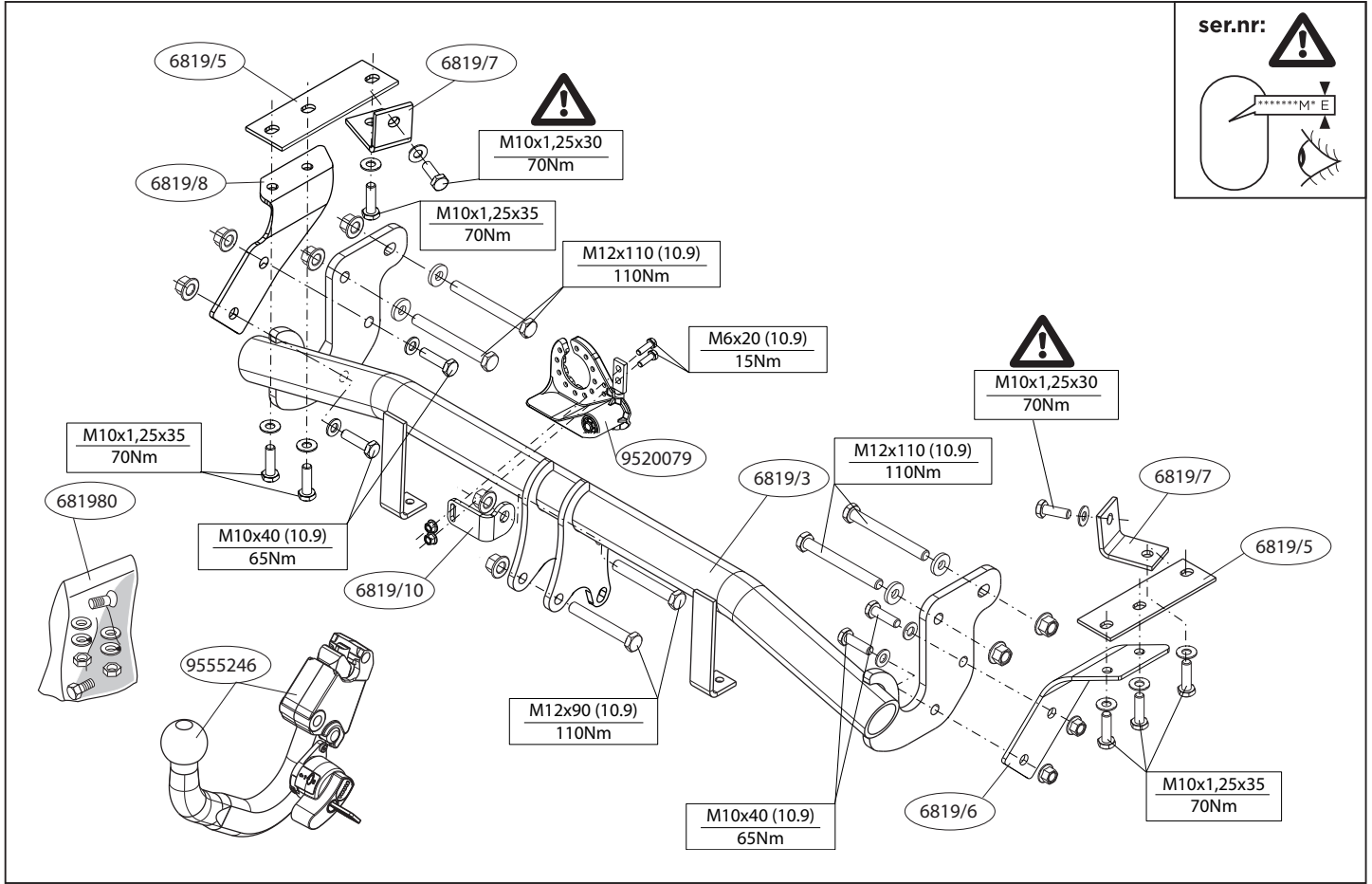







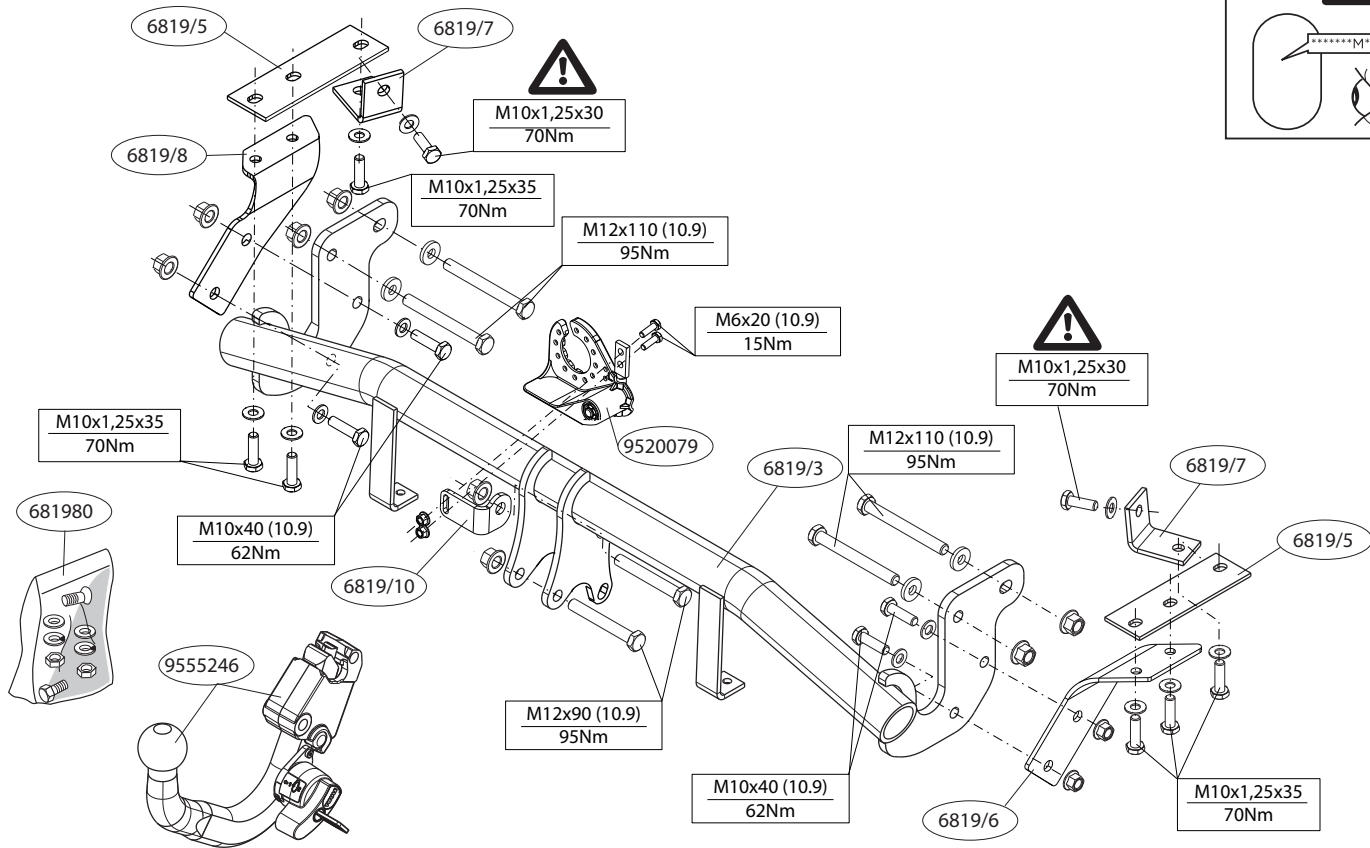
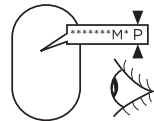

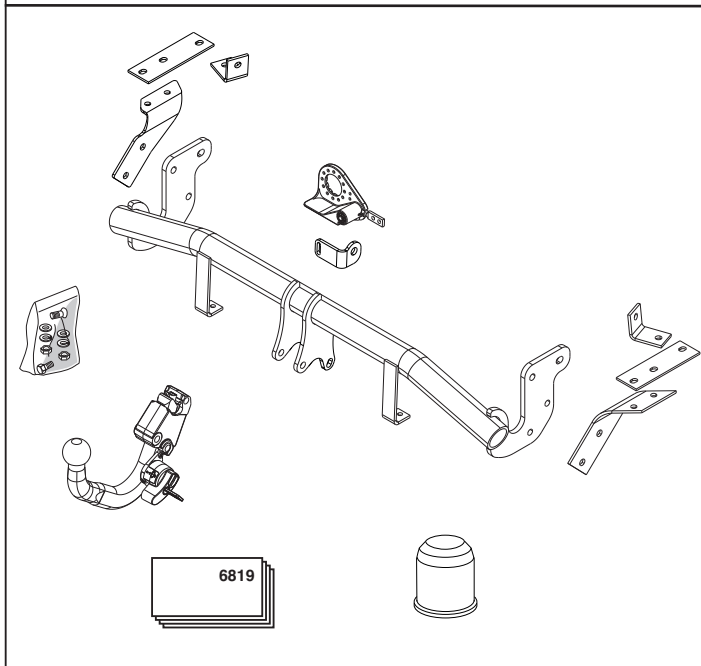
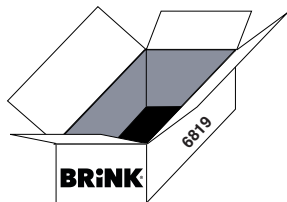



ser.nr:

*****M*E

ser.nr:





- | | | | |
|---|--------------------|---|-----------------------|
|  | (2x) M10x20 |  | (8x) M10 |
|  | (2x) M10x1.25x30 |  | (4x) M10 |
|  | (6x) M10x1.25x35 |  | (4x) M12 |
|  | (4x) M10x40(10.9) |  | (2x) self locking M6 |
|  | (4x) M12x110(10.9) |  | (4x) self locking M10 |
|  | (2x) M12x90(10.9) |  | (6x) self locking M12 |

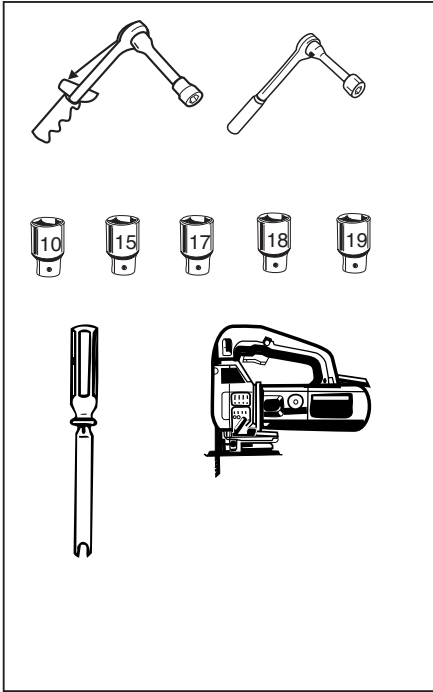

Couplingsclass: A50-X

euro tested

Approved

E11 55R 017702

ECE/55R

D-Value : 9,61 kN

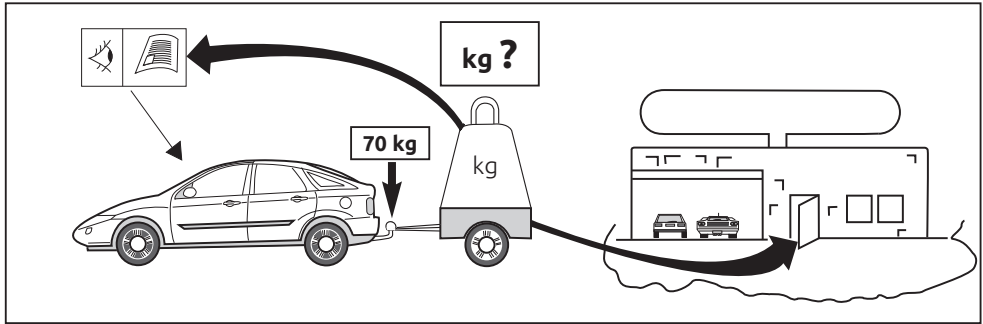

8.8

10.9

10

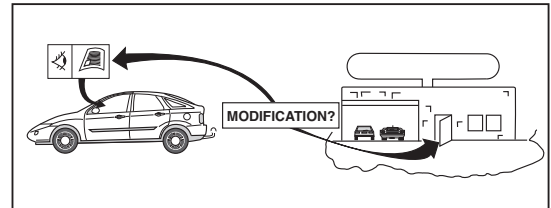



NL.

* Brink is niet aansprakelijk voor de schade die het direct of indirect gevolg is van onjuiste montage, daaronder begrepen gebruik van niet-geschikte gereedschappen en het gebruik van andere dan de voorgeschreven montagewijze en middelen, dan wel onjuiste interpretatie van dit onderhavig montagevoorschrift.

GB.

NOTE:

* **Should this installation process entail the cutting of the bumper – conformation MUST be obtained by the installation engineer of the customer’s acceptance prior to completion. Brink Towing Systems do not accept responsibility for any matters arising as a result of this miscommunication.**

All measurements are in mm!

* Brink is not liable for damage caused directly or indirectly by incorrect assembly, including the use of unsuitable tools, the use of other assembly methods and means than the ones outlined, and the incorrect interpretation of these assembly instructions.

D.

HINWEISE:

* Die für das Fahrzeug zugelassene Anhängelast ist den Fahrzeug Unterlagen zu entnehmen. Bei Änderungen des Fahrzeuggewichtes muß die höchstzulässige Anhängelast gegebenenfalls aus dem D-Wert nachgerechnet werden.

Auskunft hierüber kann Ihr Fachhändler oder der TÜV geben.

* Elektrische Anlage gemäß StVZO anbringen.

* Brink haftet nicht für Schäden, die als direkte oder indirekte Folge einer nicht ordnungsgemäßen Montage auftreten, darunter fallen auch die Benutzung von ungeeigneten Werkzeugen, andere als die vorgeschriebenen Montageverfahren und Montagemittel sowie eine fehlerhafte Interpretation der betreffenden Montageanweisung.

F.

* Brink décline toute responsabilité pour les dommages qui pourraient directement ou indirectement résulter d’un montage incorrect, y compris l’utilisation d’outils inappropriés et l’utilisation d’un mode d’emploi et de moyens autres que ceux prescrits, ou bien résulter d’une interprétation inexacte des présentes instructions de montage.

S.

* Brink är inte ansvariga för skada som orsakats direkt eller indirekt av felaktig montering, inklusive användning av olämpliga verktyg, andra monteringsmetoder och processer än de som beskrivs, samt felaktig tolkning av dessa monteringsinstruktioner.

DK.

* Brink er ikke ansvarlig for skade der direkte eller indirekte er forårsaget af forkert montage, herunder også iberegnet brug af forkert værktøj og anvendelse af anden montage metode og andre montage midler end de foreskrevne samt fejltolkning af den medfølgende montagevejledning.

E.

* Brink no se responsabiliza por daños causados, directa o indirectamente, por un montaje incorrecto, incluyendo el uso de herramientas inadecuadas, por el uso de métodos de montaje y medios distintos a los indicados y por la interpretación incorrecta de estas instrucciones de montaje.

I.

* Brink non può essere ritenuta responsabile per eventuali danni direttamente o indirettamente dovuti ad un errato montaggio, intendendo con ciò anche l'uso di attrezzi non idonei e l'uso di metodi e mezzi di montaggio diversi da quelli prescritti, nonché all'errata interpretazione delle seguenti istruzioni di montaggio.

PL.

* Firma Brink nie ponosi odpowiedzialności za straty poniesione pośrednio lub bezpośrednio na skutek niewłaściwego montażu, w tym użycia

niewłaściwych narzędzi i sposobów montażu niezgodnych z instrukcją, oraz niezastosowanie się do treści instrukcji.

SF.

* Brink ei ole vastuussa vioittumisesta, joka on suoraan tai epäsuoraan aiheutunut väärästä asennuksesta samoin kuin sopimattomien työkalujen käytöstä, muiden kuin ohjeissa mainittujen asennusmenetelmien tai välineiden käytöstä sekä kyseisten asennusohjeiden väärintulkinnasta.

CZ.

* Společnost Brink neodpovídá za přímé ani nepřímé škody způsobené nesprávnou montáží, včetně použití nevhodných nástrojů, použití jiných metod montáže a prostředků než uvedených a nesprávným pochopením těchto pokynů k montáži.

H.

* A Brink nem vállal felelősséget a nem megfelelő szerelésből közvetlen vagy közvetett módon következő károkért. Ez vonatkozik a nem megfelelő szerszámok használatára, a leírtaktól eltérő módszerek és eszközök alkalmazására, valamint a szerelési útmutató téves értelmezésére.

RUS.

* Фирма Brink не отвечает за ущерб, являющийся прямым или косвенным следствием неправильного монтажа, в том числе использования неподходящих инструментов и применения иного способа монтажа или других средств, чем предписано в инструкции, либо неправильного истолкования настоящей инструкции по монтажу.

